

GANGA DIRECTA

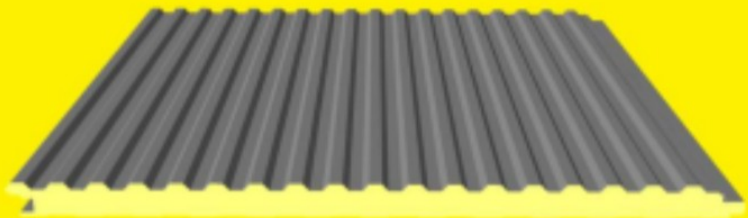

info@gangadirecta.com



WWW.GANGADIRECTA.COM



PANEL DE COBERTURA DE POLIURETANO (PUR O PIR)

PANEL TEJA® (Con chapa de Acero o Aluminio lacada)

(MARCA Y DISEÑO REGISTRADOS EN EL INPI)

ESPEORES DE MEDIA: 40 - 60 mm

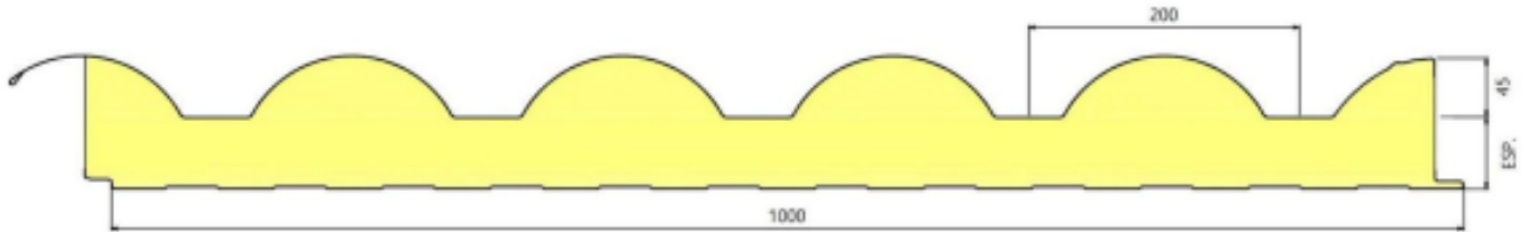
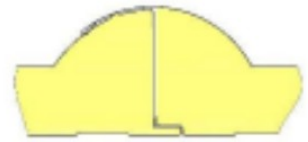

PANEL IMITACIÓN AZULEJO DE MARSELLA® (Con chapa de Acero o Aluminio lacada)

(MARCA Y DISEÑO REGISTRADOS EN EL INPI)

ESPEOR DE MEDIA: 50 mm

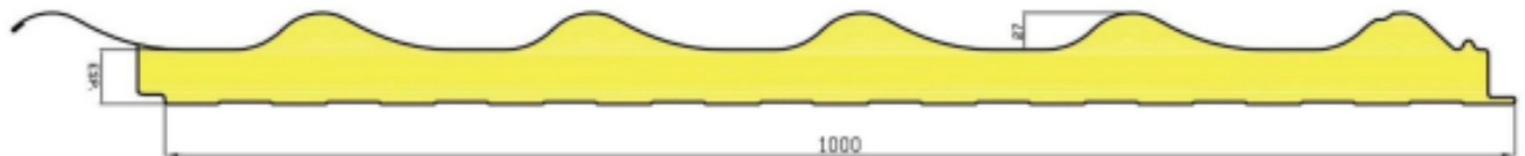

LONGITUDES PRODUCIDAS:

2.100mm	2.450mm	2.800mm	3.150mm	3.500mm	3.850mm	4.200mm	4.550mm	4.900mm	5.250mm
5.600mm	5.950mm	6.300mm	6.650mm	7.000mm	7.350mm	7.700mm	8.050mm	8.400mm	8.750mm
9.100mm	9.450mm	9.800mm	10.150mm	10.500mm	10.850mm	11.200mm	11.550mm	11.900mm	12.250mm
12.600mm	12.950mm	13.300mm	13.650mm	14.000mm	14.350mm	14.700mm	15.050mm	15.400mm	15.750mm

Otras longitudes bajo pedido.

PANEL DE POLIURETANO COBERTURA 5 ONDAS

REF: "MC 1000/5"

ESPEORES: 30 - 40 - 50 - 60 - 80 - 100 mm

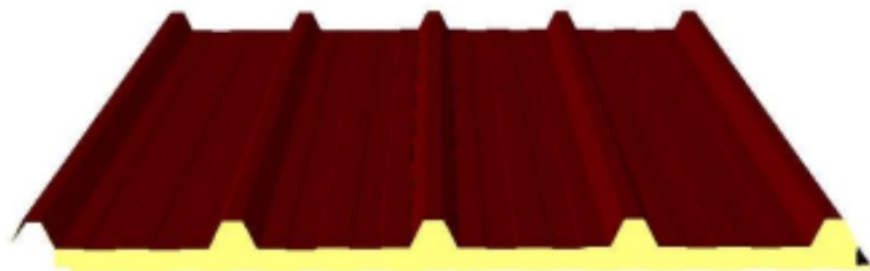

PANEL DE POLIURETANO COBERTURA 4 ONDAS

REF: "MC 1000/4"

ESPEORES: 30 - 40 - 50 - 60 - 80 - 100 mm

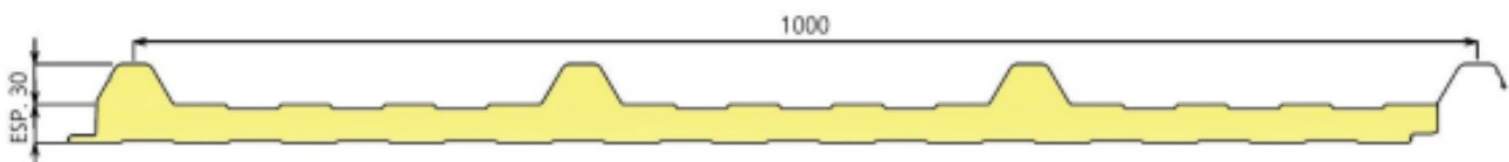

PANEL POLIURETANO TAPAJUNTAS 4 ONDAS

REF: "MC 1000/TJ"

ESPEORES: 30 - 40 - 50 - 60 - 100 mm

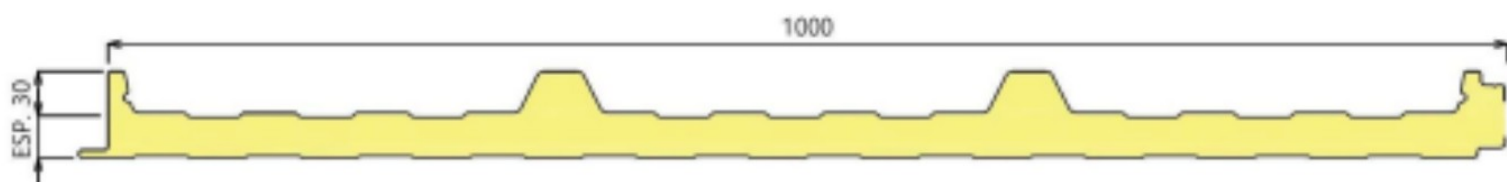
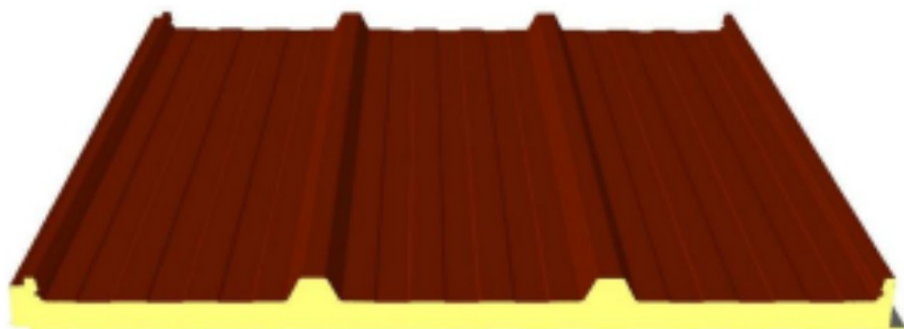

PANEL AGRO® (PLACA DE FIBRA EN EL INTERIOR)

5 ONDAS

ESPEORES: 30 - 40 - 50 - 60 - 80 - 100 mm

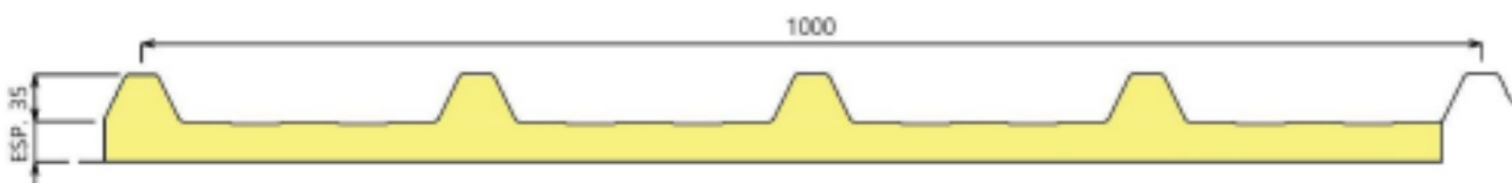

PANEL DE FACHADA DE POLIURETANO (PUR o PIR)

PANEL DE FACHADA CON FIJACIÓN OCULTA Y JUNTA CERRADA/ABIERTA TIPO A

REF: "MF 1000 JF/A" ou "MF 1000 JA/A"

ESPESORES: 40 - 50 - 60 mm

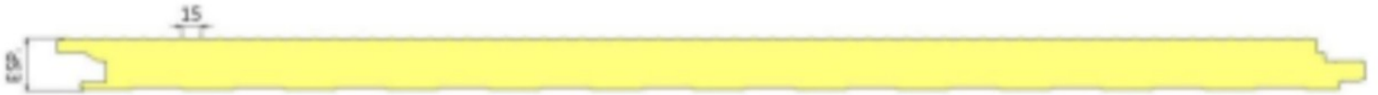
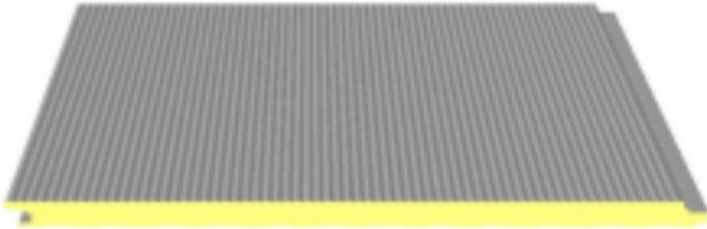

PANEL DE FACHADA CON FIJACIÓN OCULTA Y JUNTA CERRADA/ABIERTA TIPO B

REF: "MF 1000 JF/B" ou "MF 1000 JA/B"

ESPESORES: 40 - 50 - 60 mm

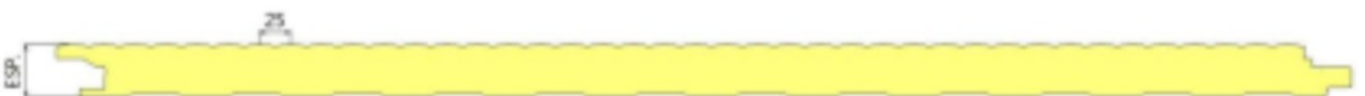
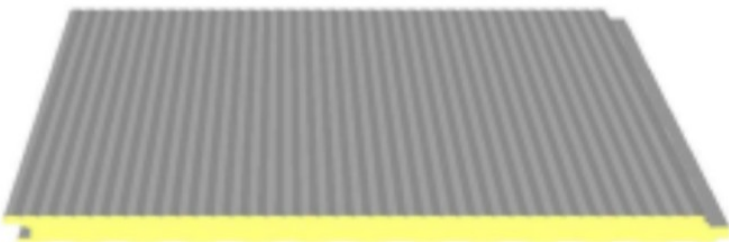

PANEL DE FACHADA CON FIJACIÓN OCULTA Y JUNTA CERRADA/ABIERTA TIPO C

REF: "MF 1000 JF/C" ou "MF 1000 JA/C"

ESPEORES: 40 - 50 - 60 mm

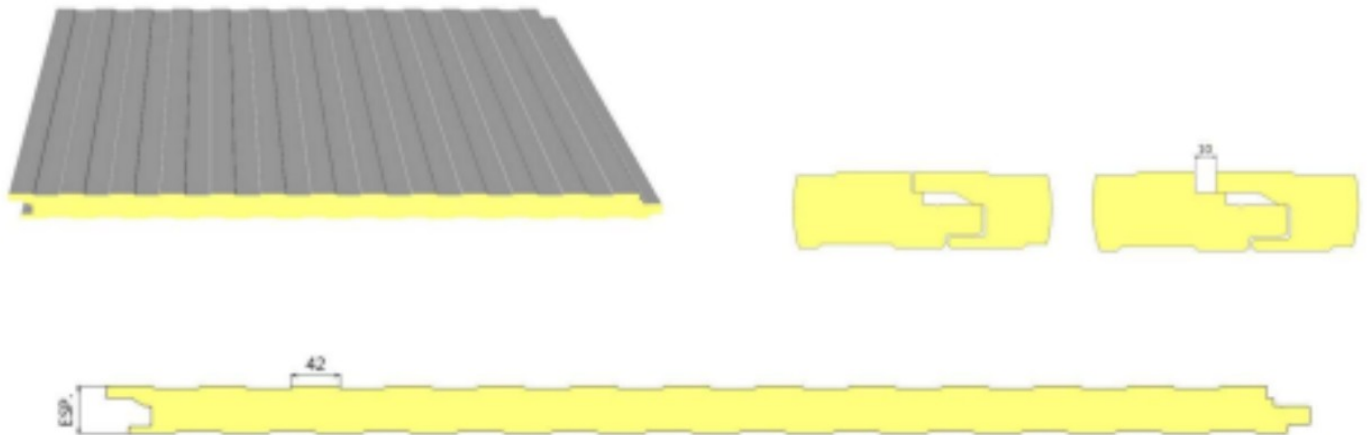

PANEL DE FACHADA CON FIJACIÓN OCULTA Y JUNTA CERRADA/ABIERTA TIPO D

REF: "MF 1000 JF/D" ou "MF 1000 JA/D"

ESPEORES: 40 - 50 - 60 mm

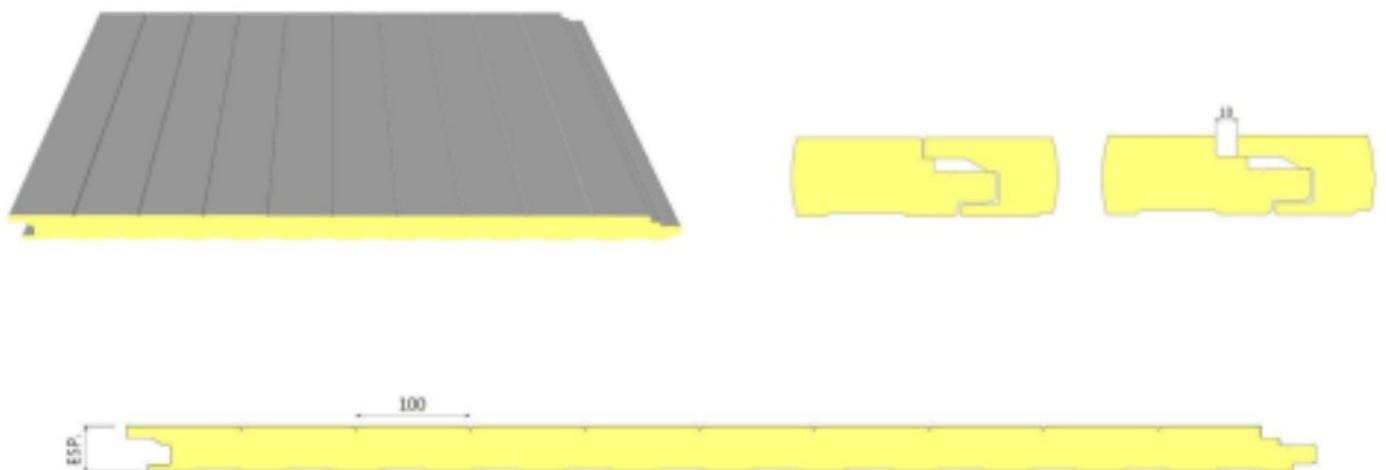

PANEL DE POLIURETANO MP-10(Modelo registrado no INPI)

REF: "MF 10-1000"

ESPEORES: 50 - 60 - 70 - 80 - 100 mm



PANEL 600 DE FACHADA FIJACIÓN OCULTA JUNTA CERRADA/ABIERTA LISO o ACANALADO

REF: "MF 600 JF/JA"

ESPEORES: 40 - 50 - 60 mm

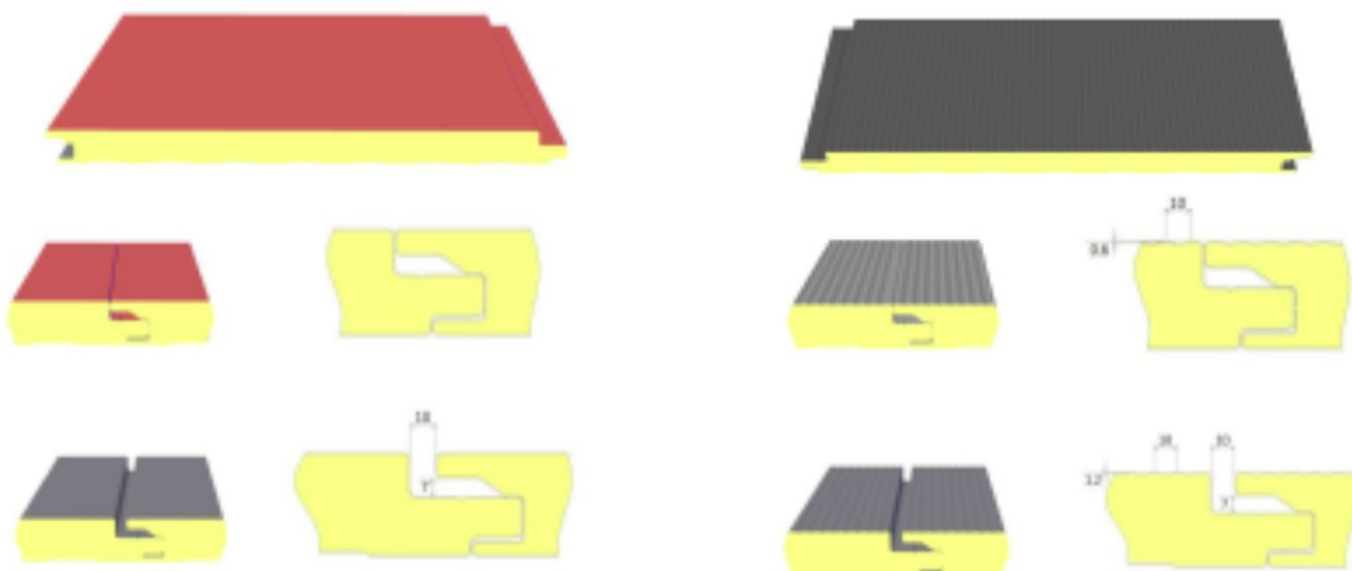

PANEL DIVISOR / FALSO TECHO EN POLIURETANO (PUR o PIR)

PANEL DE POLIURETANO DIVISOR / FALSO TECHO TIPO A

REF: "MR 1000 A"

ESPEORES: 30 - 40 - 50 - 60 - 80 - 100 mm

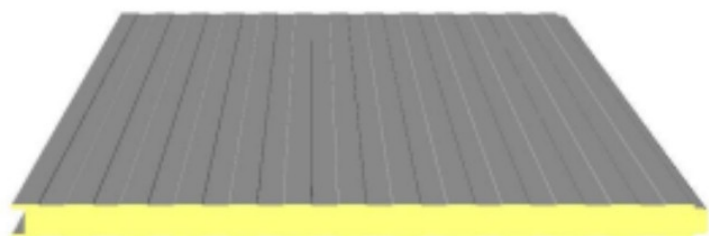

CE

PANEL DE POLIURETANO DIVISOR / FALSO TECHO TIPO B

REF: "MR 1000 B"

ESPEORES: 30 - 40 - 50 - 60 - 80 - 100 mm

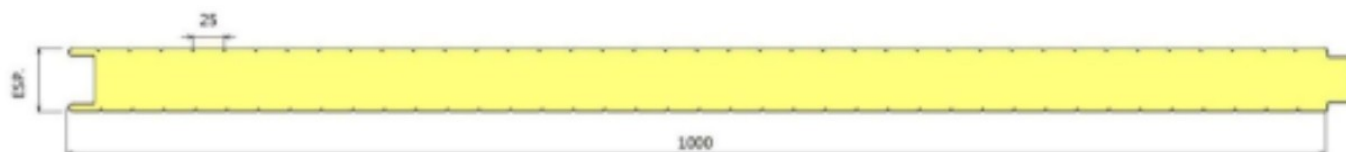
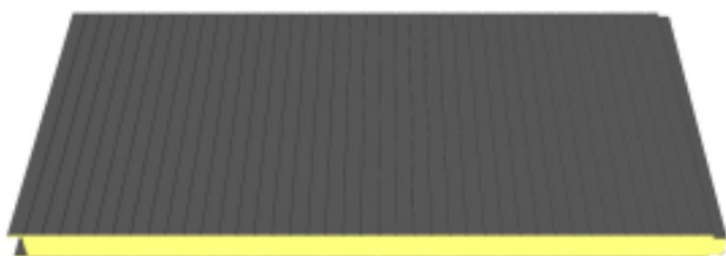

CE

PANEL DE POLIURETANO DIVISOR / FALSO TECHO TIPO C (liso 1 o 2 lados)

REF: "MR 1000 C1" o "MR 1000 C2"

ESPEORES: 30 - 40 - 50 - 60 - 80 - 100 mm

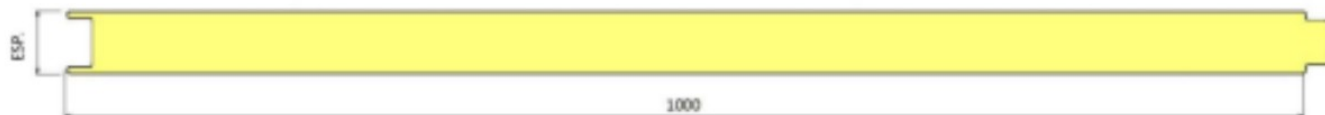

CE

MUNDIDECK®(CHAPA COLABORANTE CERTIFICADA)

MAPA DE CARGAS DISPONIBLE EN LA FICHA TÉCNICA

ESPEORES: 0'7 - 0'8 - 1 - 1'2 mm

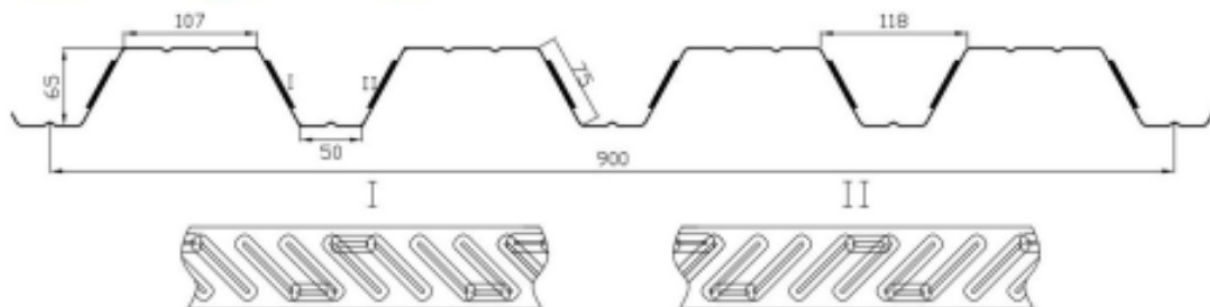
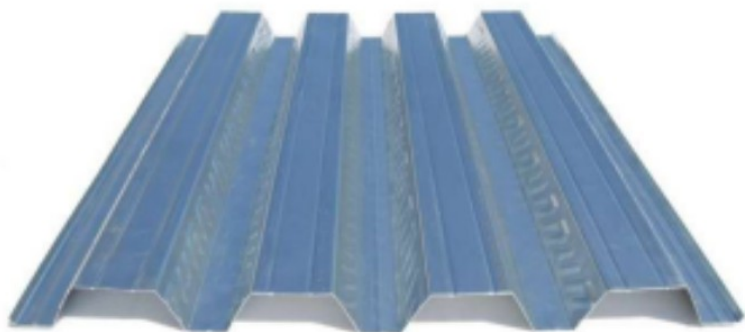

MP-45/1000 (CHAPA CON SUPERFICIE RUGOSA)

ESPESOR: 0'5 mm



CHAPA MUNDIMARSELHA® (CHAPA CON SUPERFICIE RUGOSA)

ESPESOR: 0'5 mm



MP-40/1000

ESPEORES: 0'4 - 0'5 - 0'6 mm

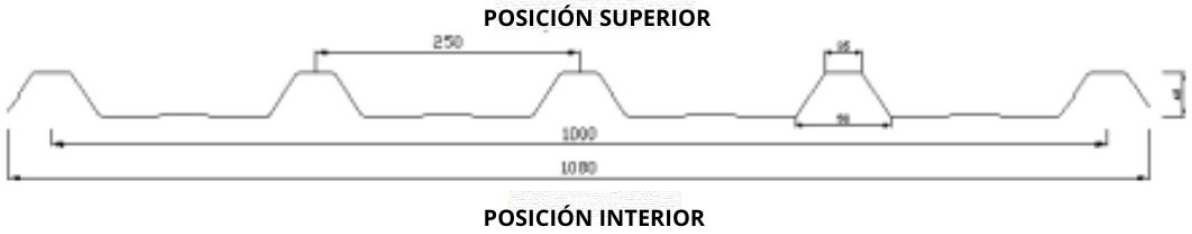
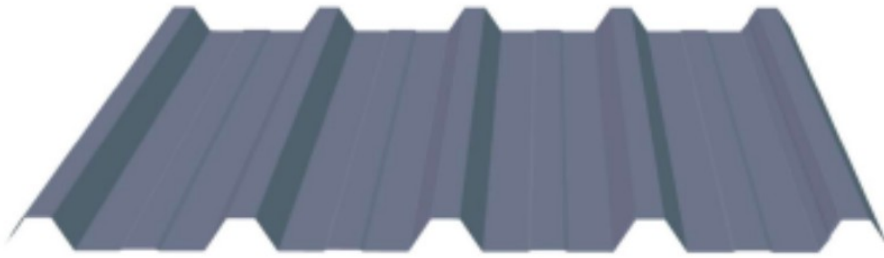

MP-30/1100/1

ESPEORES: 0'4 - 0'5 - 0'6 mm

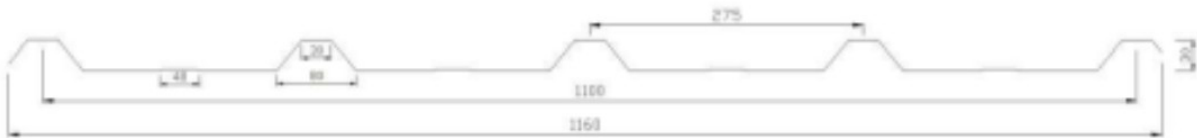

MP-30/1100/2

ESPEORES: 0'4 - 0'5 - 0'6 mm

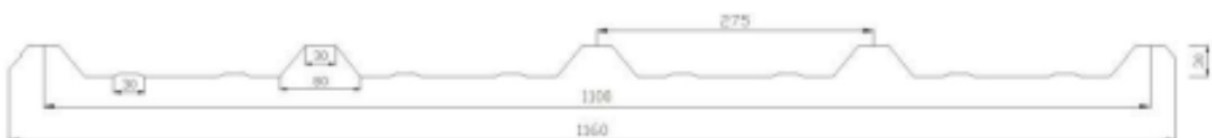

MP-30/1100/3

ESPEORES: 0'4 - 0'5 - 0'6 mm

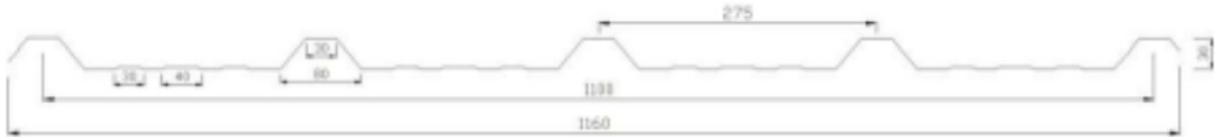
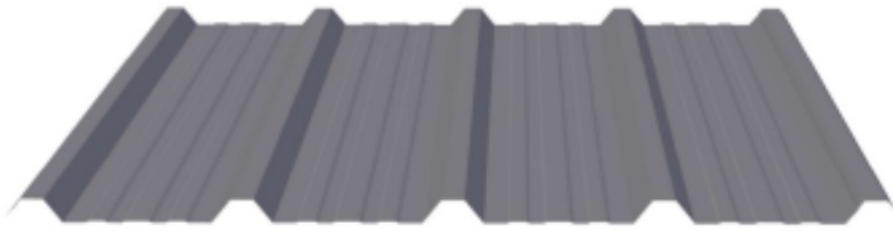

MP-28/1050

ESPEORES: 0'4 - 0'5 - 0'6 mm

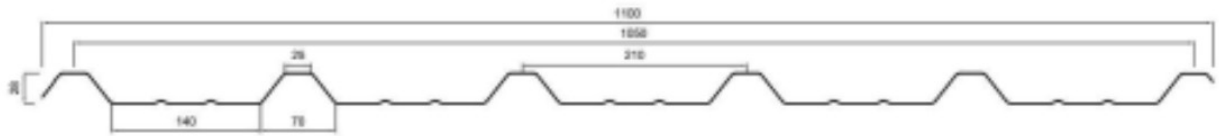

MP-25/1000

ESPEORES: 0'4 - 0'5 - 0'6 mm

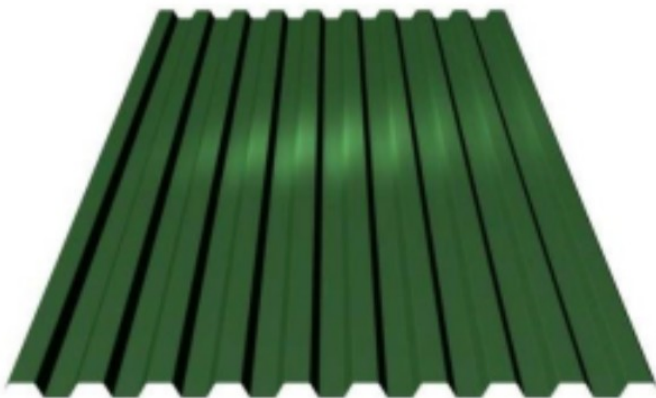

MP-18/1064

ESPEORES: 0'4 - 0'5 - 0'6 mm

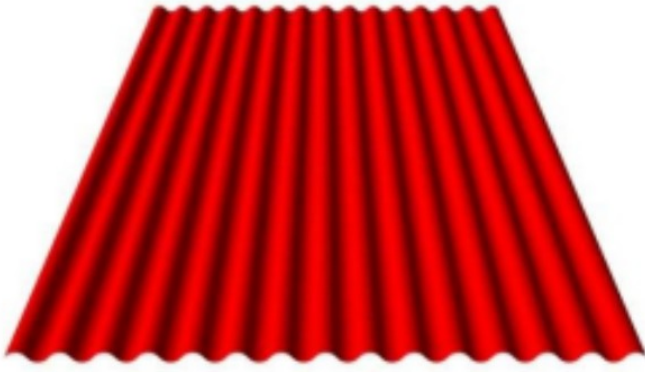

CE

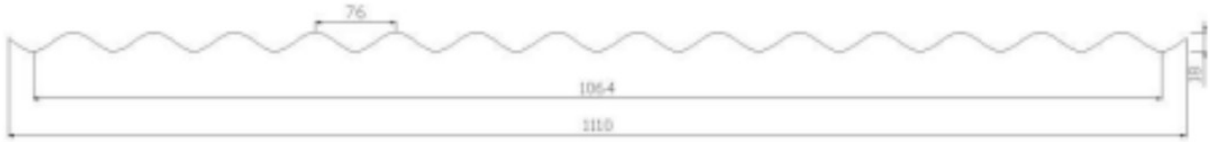

MP-12/1100

ESPEORES: 0'4 - 0'5 - 0'6 mm

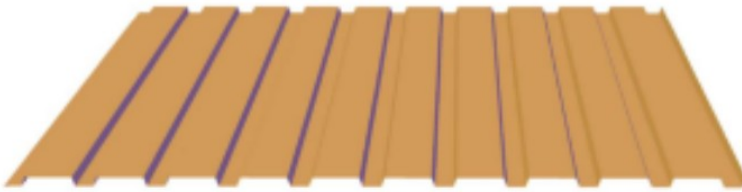

CE



MP-10/1040

ESPEORES: 0'4 - 0'5 - 0'6 mm



CE

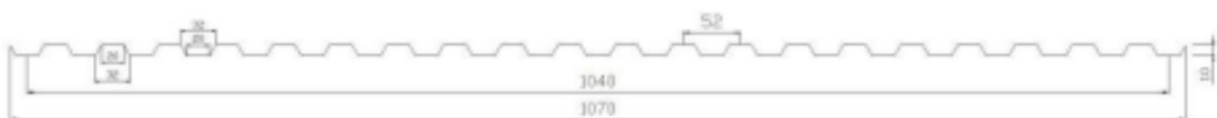

**REMATES PARA TEJA / AZULEJO DE MARSELLA®
(REALIZAMOS CUALQUIER ACABADO SEGÚN EL DISEÑO DEL CLIENTE)**

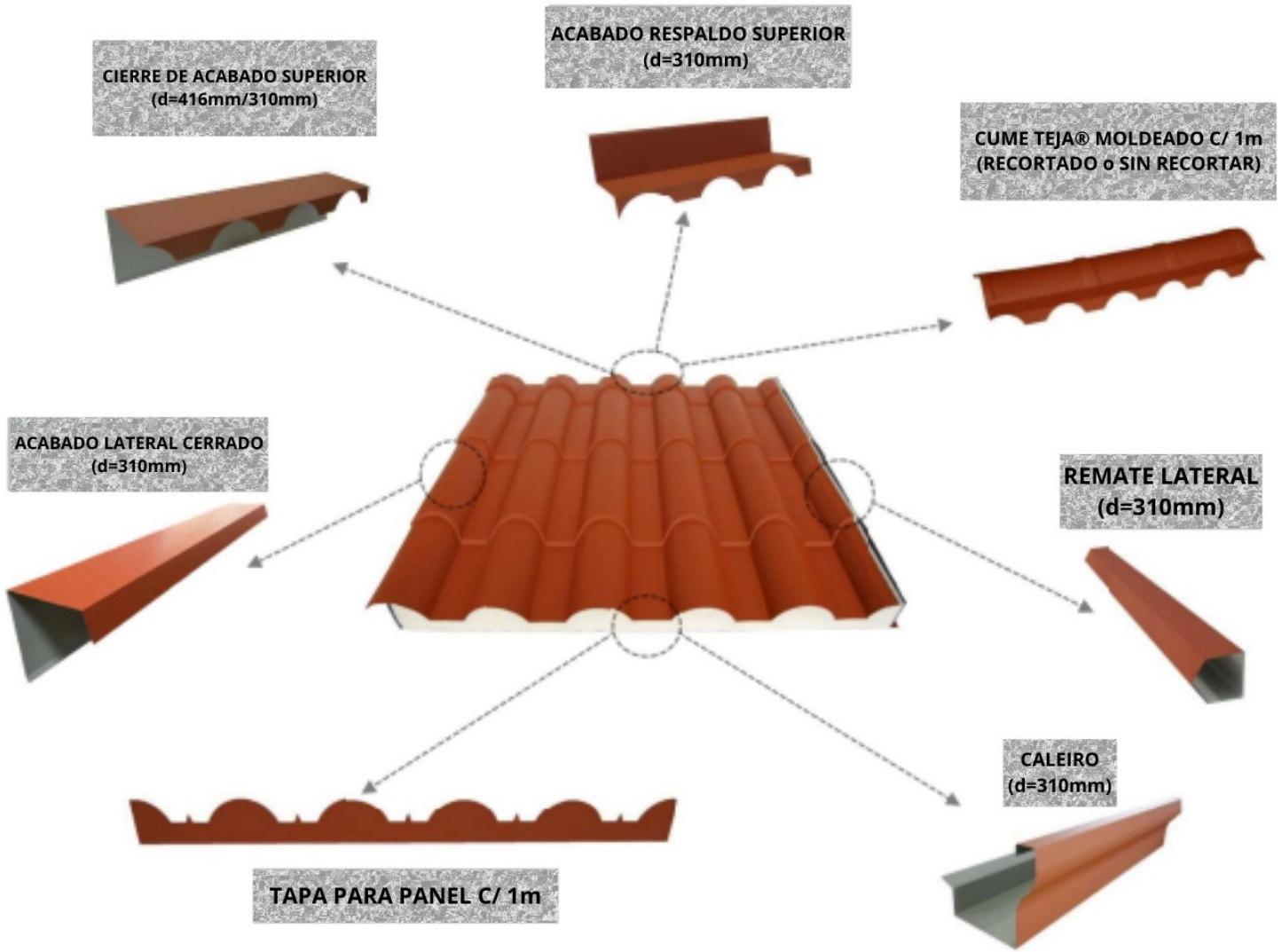

**OTROS REMATES
(REALIZAMOS CUALQUIER ACABADO SEGÚN EL DISEÑO DEL CLIENTE)**



Borde Superior con Respaldo



Cumbrera



Cierre de Acabado Superior



Cumbrera Ventilada



Esquina Exterior

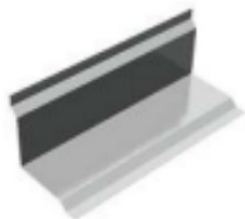

Esquina Interior

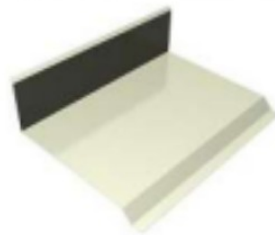

Remate Lateral con Respaldo

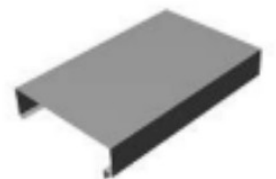

Tapa de Acabado

PERFILES en "Z"

GALVANIZADOS o LACADOS

ESPESORES: 1'5 - 2'0 - 2'5 mm

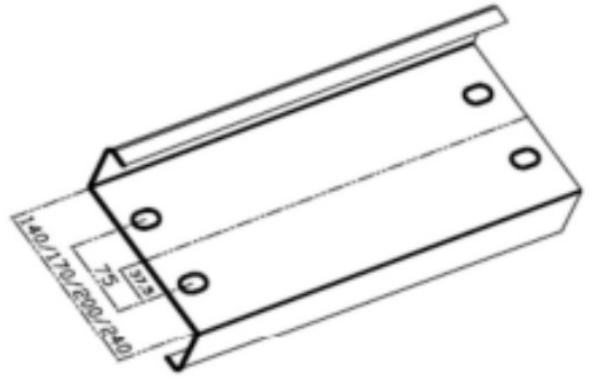
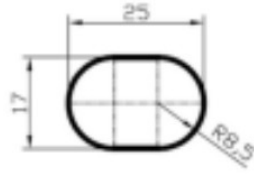
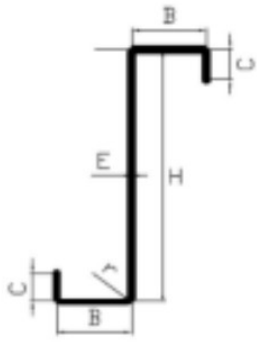

PERFILES en "C"

GALVANIZADOS o LACADOS

ESPESORES: 1'5 - 2'0 - 2'5 mm

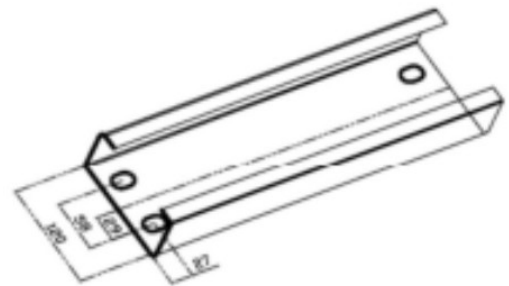
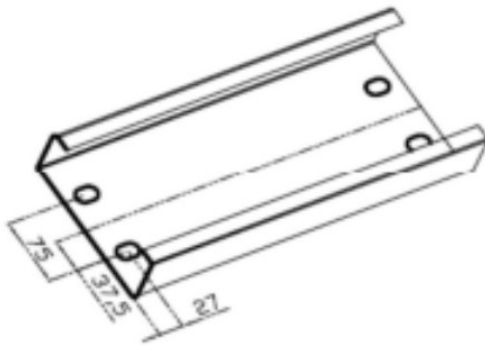
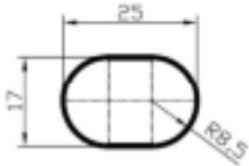
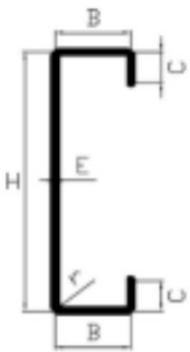

PERFILES en "Ω"

GALVANIZADOS o LACADOS

ESPESORES: 1'5 - 2'0 - 2'5 mm

OMEGA 80

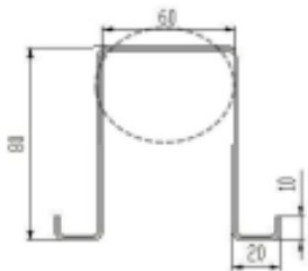

OMEGA 100



OMEGA 130

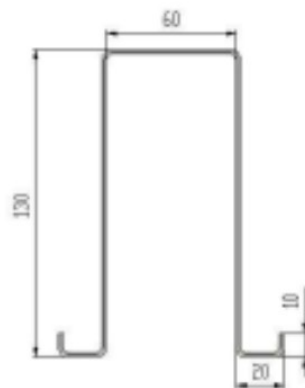

OMEGA 150

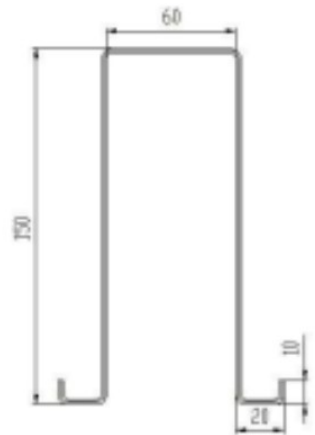

COLORES CON ACABADO RUGOSO DE POLIÉSTER



Barro RAL 8023



Barro RAL 8004



Preto RAL 9005



Cinza RAL 7022



Cast. RAL 8017



Imitação Teja Vieja Oscura



Imitação Teja Vieja Clara

COLORES CON ACABADO IMITACIÓN MADERA



Madera Intermedia



Madera Clara
(Utilizada en Exteriores)



Madera NVI
(Utilizada en Exteriores)

COLORES CON RECUBRIMIENTO DE POLIÉSTER DE 25 µ



Branco RAL 9010



Telha RAL 3009



Metal RAL 9006



Creme RAL 1015



Verde RAL 6005



Cinza RAL 7016



Azul RAL 5010



Metal RAL 9007



Cinza RAL 7022



Gris Pérola RAL 7038



Cinza RAL 7012



Preto RAL 9005



Telha RAL 8004



Vermelho RAL 3000



Amarelo RAL 1018

